

特性 FEATURES

- 30A 触点切换能力
 - 触点与线圈间耐压 3.5KV
 - 敞开型、塑封型和防尘罩型可供选择
 - F 级线圈绝缘等级
 - 外形尺寸 31.8 × 27.1 × 19.4mm
-
- 30A switching capability
 - 3.5KV dielectric strength (Between coil and contacts)
 - Open type, sealed and dust protected available
 - Class F insulation available
 - Outline dimensions 31.8 × 27.1 × 19.4mm

触点参数 CONTACT PARAMETERS

触点形式	Contact Arrangement	1A、1B、1C
触点材料	Contact Material	银合金 Silver Alloy
接触电阻 (初始)	Contact Resistance(Initial)	≤100mΩ (1A 6VDC)
额定负载 (阻性)	Rated Load(Res.)	NO: 30A 240VAC/30VDC
		NC: 20A 240VAC/30VDC
最大切换电流	Max. Switching Current	NO: 30A
		NC: 20A
最大切换电压	Max. Switching Voltage	240VAC/30VDC
最大切换功率	Max. Switching Power	7200VA/560W
电气寿命	Electrical Life	1 × 10 ⁵ 次 OPS
机械寿命	Mechanical Life	1 × 10 ⁶ 次 OPS

性能参数 FUNCTION PARAMETERS

绝缘电阻	Insulation Resistance	1000MΩ (500VDC)
介质耐压	Dielectric Strength	触点与线圈间 Bet ween Coil & Contacts: 3500VAC 1min
		断开触点间 Between Open Contacts: 1000VAC 1min
动作时间	Operate Time	≤15ms
复归时间	Release Time	≤10ms
环境温度	Ambient Temperature	-40℃ ~+105℃
振动	Vibration	10Hz~55Hz 1.5mm 双振幅 (DA)
冲击	Shock	稳定性 Functional: 98m/s ² (10G)
		强度 Destructive: 980m/s ² (100G)
引出端方式	Terminal Form	印制板式 PCB
封装形式	Construction	敞开型, 塑封型 Unenclosed, Sealed
重量	Unit Weight	约 Approx. 36g

线圈规格表 COIL DATA(23℃)

额定电压 Rated Voltage VDC	动作电压 Operate Voltage VDC	释放电压 Release Voltage VDC	最大允许电压 Max Allowable Voltage VDC	线圈电阻 Coil Resistance Ω ± 10%	线圈功耗 Coil Power W
5	≤3.75	≥0.5	6.5	28	约 Approx. 0.9
6	≤4.5	≥0.6	7.8	40	
9	≤6.75	≥0.9	11.7	90	
12	≤9.0	≥1.2	15.6	160	
18	≤13.5	≥1.8	23.4	360	
24	≤18	≥2.4	31.2	640	
48	≤36	≥4.8	62.4	2560	
110	≤82.5	≥11	143	13440	

安全认证 APPROVALS

安全认证 Approvals	UL	TUV	CQC
证书编号 Certificate Number	E358149	R50184977	CQC10002051838
负载 Rating	1A: 30A 240VAC 20A 30VDC 1B: 20A 240VAC/30VDC 1C(NO): 30A 240VAC 20A 30VDC 1C(NC): 20A 240VAC/30VDC	1A: 30A 240VAC/30VDC 1C(NO): 20A 240VAC/30VDC 1C(NC): 10A 240VAC/30VDC	NO: 30A 240VAC/30VDC NC: 20A 240VAC/30VDC

订货标记示例 ORDERING INFORMATION

产品型号 Model:	MPQ1	-S	-1	12	D	-C	-6
产品结构 Structure:	S: 塑封型 Sealed 无 Nil: 敞开型 Unenclosed						
触点组数 Contact Group:	1: 1组 1 Group						
线圈电压 Coil Voltage:	5、6、9、12、18、24、48、110 VDC						
线圈电源 Coil Power:	D: 直流 DC A: 常开 NO						
触点形式 Contact Arrangement:	B: 常闭 NC C: 转换 NO/NC						
引出端形式 Termination:	6: 有 6 号引出脚 (With #6 Terminal) 无 Nil: 没有 6 号引出脚 (Without #6 Terminal)						

外形尺寸、接线图、安装孔尺寸 OUTLINE DIMENSIONS, WIRING DIAGRAM AND PCB LAYOUT (单位 Unit: mm)

外形尺寸 Outline Dimensions

接线图 Wiring Diagram
(底视 Bottom View)

安装孔尺寸 PCB Layout
(底视 Bottom View)

一组常开 (1 Form A)

包含 6 号引出脚 With 6# Terminal

不包含 6 号引出脚 Without 6# Terminal

外形尺寸 Outline Dimensions

接线图 Wiring Diagram
(底视 Bottom View)

安装孔尺寸 PCB Layout
(底视 Bottom View)

一组常闭 (1 Form B)

包含 6 号引出脚 With 6# Terminal

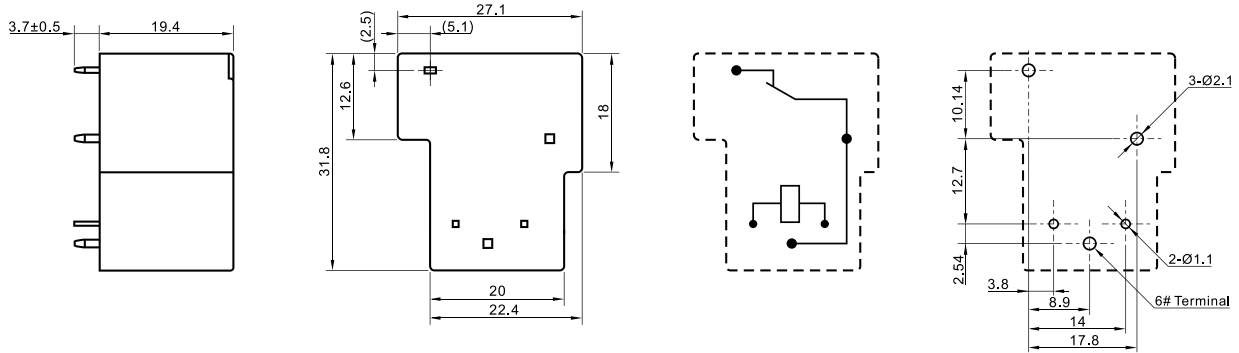

不包含 6 号引出脚 Without 6# Terminal

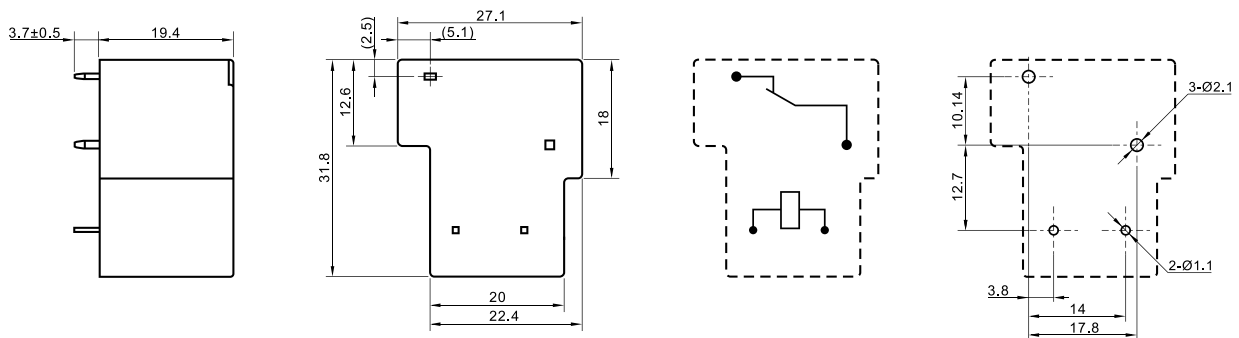

一组转换 (1 Form C)

包含 6 号引出脚 With 6# Terminal

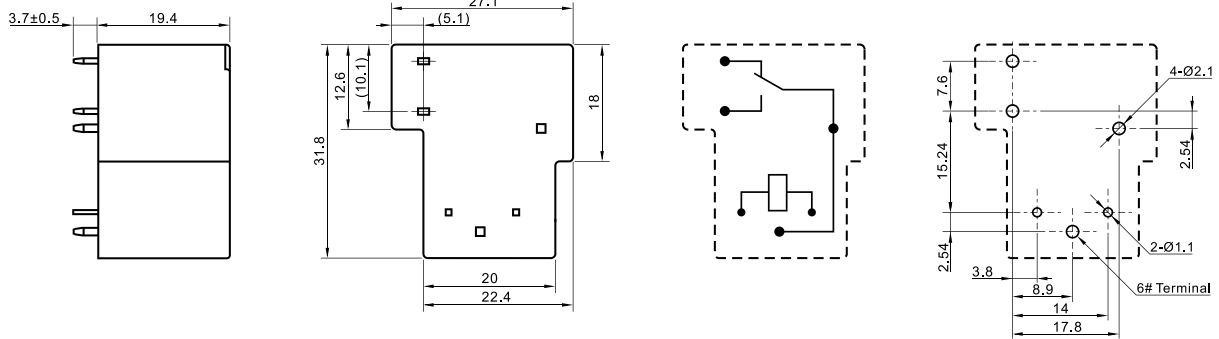

不包含 6 号引出脚 Without 6# Terminal

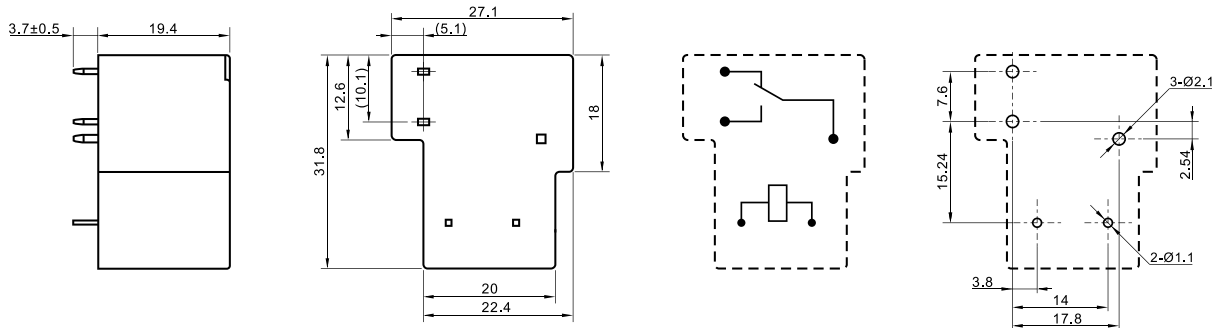

外形尺寸 Outline Dimensions

接线图 WIRING DIAGRAM
(底视 Bottom View)

安装孔尺寸 PCB LAYOUT
(底视 Bottom View)

敞开型一组常开 (1 Form A Unenclosed)

包含 6 号引出脚 With 6# Terminal

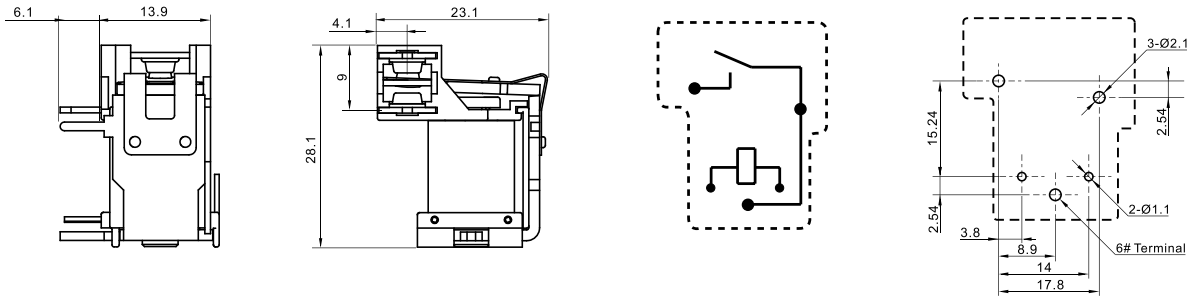

不包含 6 号引出脚 Without 6# Terminal

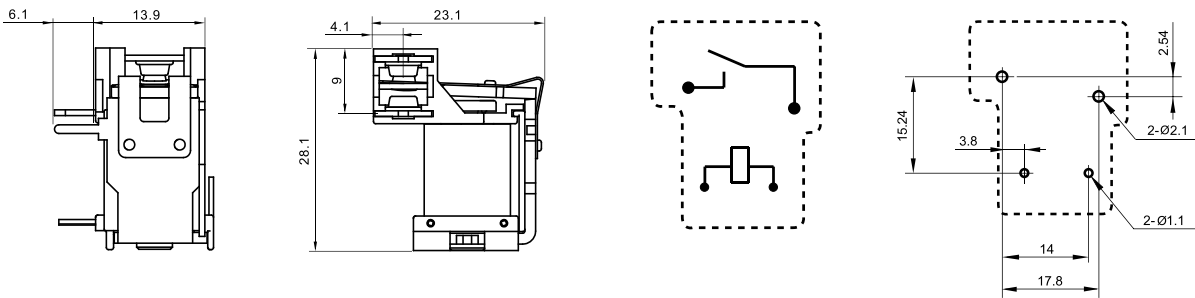

敞开型一组常闭 (1 Form B Unenclosed)

包含 6 号引出脚 With 6# Terminal

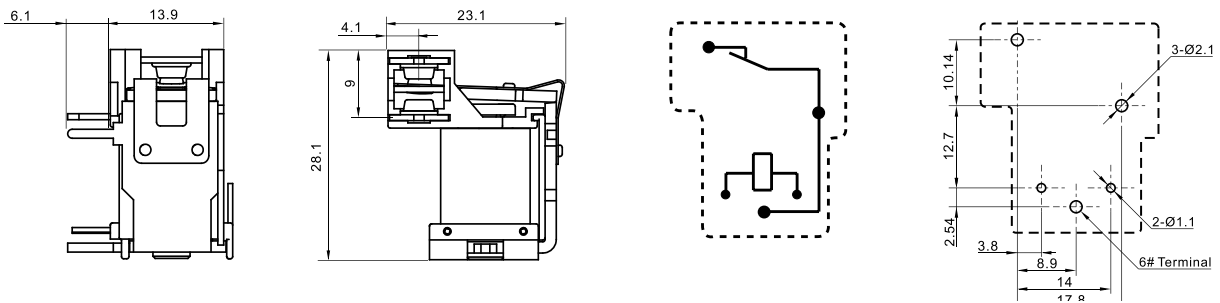

不包含 6 号引出脚 Without 6# Terminal

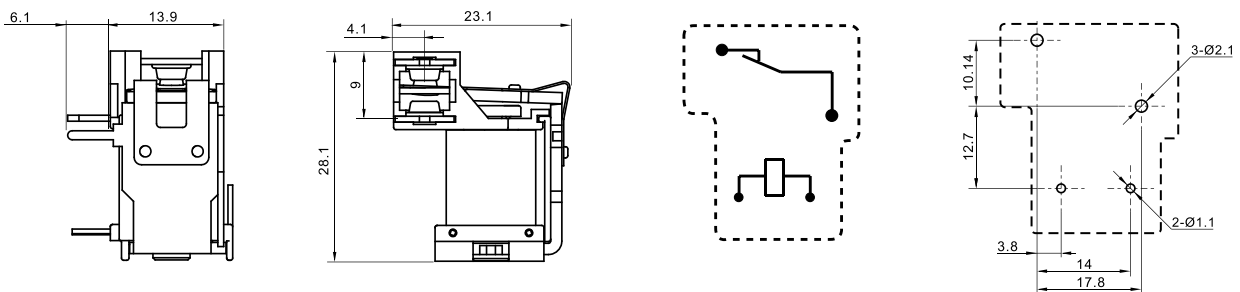

外形尺寸 Outline Dimensions

接线图 Wiring Diagram (底视 Bottom View)

安装孔尺寸 PCB Layout (底视 Bottom View)

敞开型一组转换 (1 Form C Unenclosed)

包含 6 号引出脚 With 6# Terminal

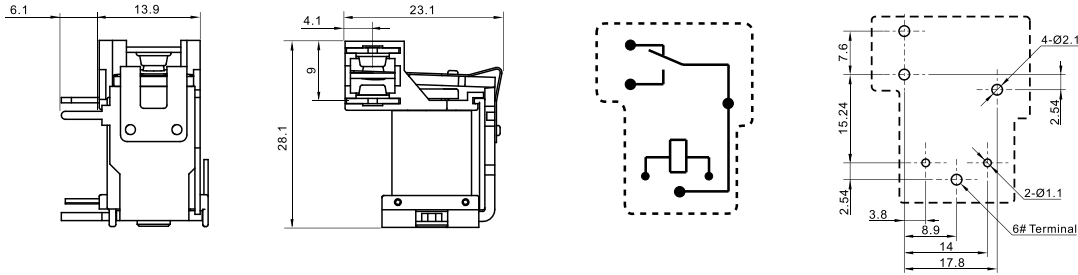

不包含 6 号引出脚 Without 6# Terminal

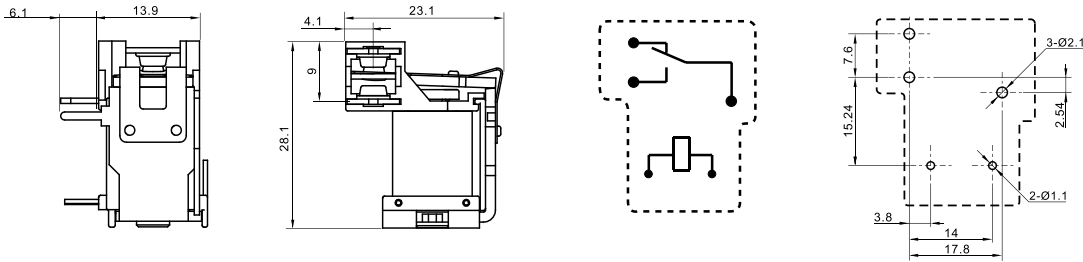

备注:

- (1) 产品部分外形尺寸未注尺寸公差, 当外形尺寸 $\leq 1\text{mm}$, 公差为 $\pm 0.2\text{mm}$; 当外形尺寸在 $1\sim 5\text{mm}$ 之间时, 公差为 $\pm 0.3\text{mm}$; 当外形尺寸 $> 5\text{mm}$ 时, 公差为 $\pm 0.4\text{mm}$;
- (2) 安装孔尺寸中未注尺寸公差均为 $\pm 0.1\text{mm}$ 。

REMARK:

- (1) In case of no tolerance shown in outline dimension: outline dimension $\leq 1\text{mm}$, tolerance should be $\pm 0.2\text{mm}$; outline dimension $> 1\text{mm}$ and $\leq 5\text{mm}$, tolerance should be $\pm 0.3\text{mm}$; outline dimension $> 5\text{mm}$, tolerance should be $\pm 0.4\text{mm}$;
- (2) The tolerance without indicating for PCB layout is always $\pm 0.1\text{mm}$.

性能曲线图 PERFORMANCE CURVE

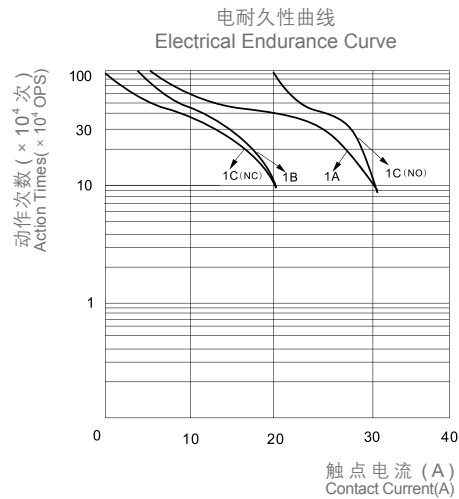
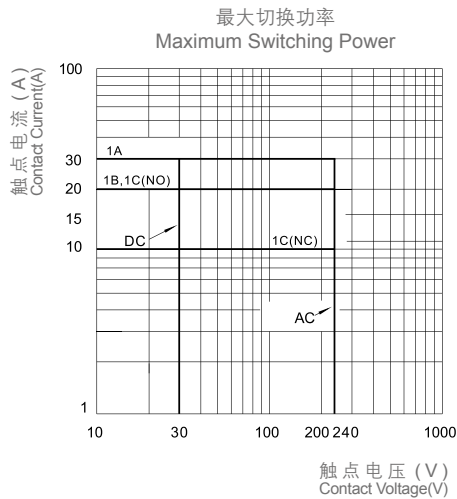

声明 STATEMENT:

本产品规格书仅供客户使用时参考, 若有更改, 恕不另行通知。

客户应根据具体的使用条件选择与之相匹配的产品。若有疑问, 请与美硕联系获取更多的技术支持, 但产品选型责任由客户承担。

This product specification is for reference only to customers, subject to change without notice.

The customer should select the matching product according to the use condition. Any questions, please feel free contact us to get more technical support. However, product selection responsibility only by the customer.